

# ***3000W PTC Fan Heater***

**IMPORTANT!** PLEASE READ THESE INSTRUCTIONS CAREFULLY. NOTE ALL SAFETY INSTRUCTIONS AND WARNINGS. USE THE PRODUCT CORRECTLY AND WITH CARE FOR THE PURPOSE FOR WHICH IT IS INTENDED. FAILURE TO FOLLOW THESE INSTRUCTIONS MAY CAUSE DAMAGE TO PROPERTY AND/OR PERSONAL INJURY.

**PLEASE KEEP THESE INSTRUCTIONS SAFE AND AVAILABLE FOR FUTURE REFERENCE.**

## ***CERTIFICATE OF GUARANTEE***

---

This product is guaranteed for a period of 1 Year, with effect from the date of purchase and applies only to the original purchaser. This guarantee only applies to defects arising from, defective materials and or faulty workmanship that become evident during the guarantee period only and does not include consumable items. The manufacturer will repair or replace the product at their discretion subject to the following. That the product has been used in accordance with the guidelines as detailed in the product manual and that it has not been subjected to misuse, abuse or used for a purpose for which it was not intended. That it has not been taken apart or tampered with in any way whatsoever or has been serviced by unauthorised persons or has been used for hire purposes. Transit damage is excluded from this guarantee, for such damage the transport company is responsible. Claims made under this guarantee must be made in the first instance, directly to the retailer within the guarantee period. Only under exceptional circumstances should the product be returned to the manufacturer. In this case it shall be the consumer's responsibility to return the product at their cost ensuring that the product is adequately packed to prevent transit damage and must be accompanied with a brief description of the fault and a copy of the receipt or other proof of purchase. The manufacturer shall not be liable for any special, exemplary, direct, indirect, incidental, or consequential loss or damage under this guarantee. This guarantee is in addition to and does not affect any rights, which the consumer may have by virtue of the Sale of Goods Act 1973 as amended 1975 and 1999.

## ***INTRODUCTION***

---

Thank you for purchasing this product which has passed through our extensive quality assurance process. Every care has been taken to ensure that it reaches you in perfect condition. However, in the unlikely event that you should experience a problem, or if we can offer any assistance or advice please do not hesitate to contact our customer care department. For details of your nearest customer care department please refer to the telephone numbers at the back of this manual.

### **Safety First**

Before attempting to operate this product the following basic safety precautions should always be taken to reduce the risk of fire, electric shock and personal injury. It is important to read the instruction manual to understand the application, limitations and potential hazards associated with this product.

## ***HELPLINE & SPARE PARTS***

---

In the unlikely event of a defect occurring please contact our Helpline.  
Office hours: Monday - Friday 9:00am - 5:00pm. Telephone Number 01332 576 850

## ***INTENDED USE***

---

This heater has two heat settings with thermostat control, plus fan only option and is intended to raise the ambient temperature in garages and workshop environments and is suitable for domestic and light commercial use only.

Any other application beyond the conditions established for use will be considered misuse. SGS Engineering accepts no responsibility for improper use of this product.

## IMPORTANT SAFETY INSTRUCTIONS

The purpose of safety rules is to attract your attention to possible dangers. The safety symbols and the explanations with them, require your careful attention and understanding. The safety warnings do not by themselves eliminate any danger. The instruction or warnings they give are not substitutes for proper accident prevention measures.

### SAFETY ALERT SYMBOL



Indicates danger, warning, caution or notice. May be used in conjunction with other symbols or pictures.

**DANGER** indicates a hazardous situation which, if not avoided, will result in death or serious injury.

**WARNING** indicates a hazardous situation which, if not avoided, could result in death or serious injury.

**CAUTION** indicates a hazardous situation which, if not avoided, could result in minor or moderate injury.

**NOTICE** indicates information considered important, but not hazard-related (e.g., messages relating to property damage).

Failure to obey a safety warning can result in serious injury to yourself or to others. Always follow the safety precautions to reduce the risk of fire, electric shock and personal injury.

Do not attempt to operate this tool until you have read thoroughly and completely understood the safety rules, etc. contained in this manual. Failure to comply can result in accidents involving fire, electric shock or serious personal injury. Save this Owners Operating Manual and review it frequently for continual safe operation and for instructing others who may use this tool.

**Due to continued product refinement policy, product features and specifications can and will change without notice. Check current features and specifications with your retailer.**



**WARNING: Read and understand all instructions.** Failure to follow all instructions listed below could result in electrocution, fire, and/or explosion, which can cause death or serious injury.

### HEATER HEALTH AND SAFETY PRECAUTIONS



**WARNING: NEVER cover any part of the heater.** This may cause the heater to overheat or the covering item to ignite or burn.

The heater must only be used by people who have read these instructions and have been trained in its use.

This heater is not designed to be operated by persons who have insufficient experience and/or insufficient knowledge or by persons with impaired physical, sensory or mental capabilities, unless they are being supervised by a person who is responsible for their safety or they are receiving instructions about how these devices are to be used. Children shall not play with the device. Cleaning and user maintenance shall not be made by children without supervision.

Keep your work environment clear and well-lit, with bystanders at a safe distance.

Before every use, inspect the heater for broken, cracked, loose or corroded parts.



**WARNING: DO NOT use this product if it is damaged in any way. Contact SGS Engineering to discuss repair and replacement options.**

**DO NOT** modify the heater in any way.

This heater is for indoor use only. **DO NOT** expose to rain or wet conditions.

**DO NOT** expose this product to temperatures greater than 50°C.

**DO NOT** use this heater in small rooms that are occupied by individuals that are not capable of leaving the room on their own, unless constant supervision is provided.

## **IMPORTANT SAFETY INSTRUCTIONS**

---

**DO NOT** use the heater in dusty environments.

Position the heater on a firm and level surface during use and ensure that the position adjustable knobs are tightly secured.

The heater must only be used in its upright position.

Position this product only on fire-resistant flooring.

**DO NOT** position the heater in close proximity to curtains or other combustible materials that may move and come into contact with the heater. Allow a minimum of 2m clearance between the heater outlet grille and any nearby objects.

**DO NOT** position this heater in the vicinity of combustible materials, in explosive environments or in the presence of flammable or combustible gases and vapours.

**DO NOT** position this heater below or pointing towards a power socket or outlet.

Ensure that both switches are in the "off" position before connecting the heater to the power supply.

Only use this product with power supplies that match the rated voltage of the heater.

**NEVER** use this heater on an extension lead, multi-socket or plug adaptor; it must be plugged directly into the power supply.

**NEVER** plug more than one heater into the same power outlet.

**NEVER** abuse the power cord. Untangle the power cord fully before connecting it to the power supply.

**NEVER** remove the plug from the power supply by pulling on the cord.

**DO NOT** carry the product by the cable or plug.

Keep the power cord away from sources of heat, liquids, sharp edges and moving parts.

The power cord attached to this product is not suitable for use on building sites.

**NEVER** allow the power cord to come into contact with other heated objects or direct the heater at the power cord or supply.

This is a Class I appliance. This product requires an earth connection to protect against electric shock from accessible conductive parts in the event of a failure of the basic insulation.

To reduce the risk of electric shock, avoid contact with earthed objects during use. Avoid body contact with earthed or grounded surfaces, such as pipes, radiators, ranges and refrigerators.

Always check that the heater is positioned safely before turning it on.

**NEVER** leave the heater unattended while it is on.

**DO NOT** use this heater with a programmer, timer, separate remote-control system or any other device that switches the heater on automatically, as it may be covered or positioned incorrectly when activated and pose a fire risk.

**NEVER** insert foreign objects through the grilles.

**DO NOT** operate the heater without both of the grilles installed.



**WARNING! Risk of shock! DO NOT allow the heater to come into contact with water or any other liquid.**

**DO NOT** use this heater in the vicinity of a bath, shower, swimming pool or other body of water.

**DO NOT** touch the heater with wet hands.



**WARNING! Some parts of the product become very hot during use and may cause burns.**

**DO NOT** touch the metal grille on the front or rear of the heater during or immediately after use.

Always carry the heater by the carry handle when moving the heater during and after use.

## IMPORTANT SAFETY INSTRUCTIONS

**DO NOT** attempt to adjust the angle of the heater during or immediately after use. Always switch off the heater, disconnect it from the power supply and allow it to cool for at least 20 minutes before attempting to move or reposition it.

### CONNECTION TO THE POWER SUPPLY

This appliance is supplied with an approved plug and cord for your safety. The value of the fuse fitted is marked on the pin face of the plug. Should the fuse need replacing, ensure the substitute is of the correct rating, approved to BS 1363/A and ASTA or BS Kite marked.

The fuse can be replaced by removing the cover of the plug using a cross-headed screwdriver and removing the broken fuse from its holder. This should only be performed by suitably qualified personnel.

Connect the plug to a standard, 230 Volt (50Hz) electrical supply through an approved 13 amp plug, or a suitably fused isolator switch.

If the power supply cord is damaged, it must be replaced by SGS Engineering, an authorised service agent or similarly qualified personnel in order to avoid a hazard. The damaged or incomplete plug, when cut from the cord, shall be disabled to prevent connection to a live electrical outlet.



**WARNING!** The wires in the power cable of this product are coloured in accordance with the following code:

Blue = neutral

Brown = live

Yellow and Green = earth

If the colours of the wires in the power cable do not agree with the markings on the plug:

The BLUE wire must be connected to the terminal which is marked N or coloured black.

The BROWN wire must be connected to the terminal which is marked L or coloured red.

The YELLOW and GREEN wire must be connected to the terminal which is marked E or  or coloured green.

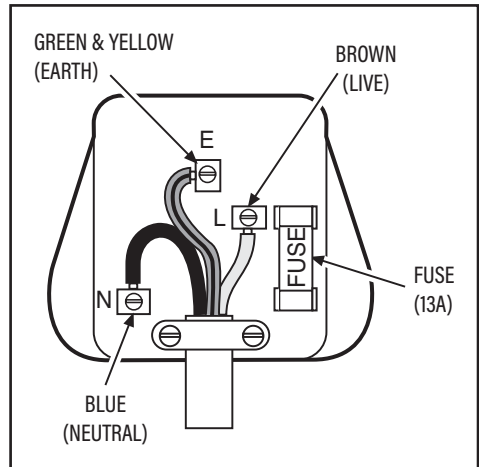

We strongly recommend that this machine is connected to the mains supply through a Residual Current Device (RCD).











If you are not sure, consult a qualified electrician. DO NOT try to do any repairs.

### RESIDUAL RISK

The safety instructions in this manual cannot account for all possible conditions and situations that may occur. Exercise common sense and caution when using this product and protect against any additional conceivable risks.

## SAFETY SYMBOLS

Some of the following symbols may be used on this product. Please study them and learn their meaning. Proper interpretation of these symbols will allow you to more safely operate the product.

SYMBOL	DESIGNATION/EXPLANATION
	Do not expose to rain or use in damp locations.
	To reduce the risk of injury, the user must read and understand the operator's manual before using this product.
	Never cover any part of the heater. This may cause the heater to overheat or the covering item to ignite or burn.
	Precautions that involve your safety.
	Do not incinerate or throw onto fire.
	Danger of electric shock.
	For indoor use only, do not expose to rain.
	To reduce the risk of injury or damage, avoid contact with any hot surface.
	Class I appliance, Earthed.
	Waste electrical products should not be disposed of with household waste. Please recycle where facilities exist. Check with your Local Authority or retailer for recycling advice.
	Conforms to relevant safety standards.

## COMPONENTS & CONTROLS

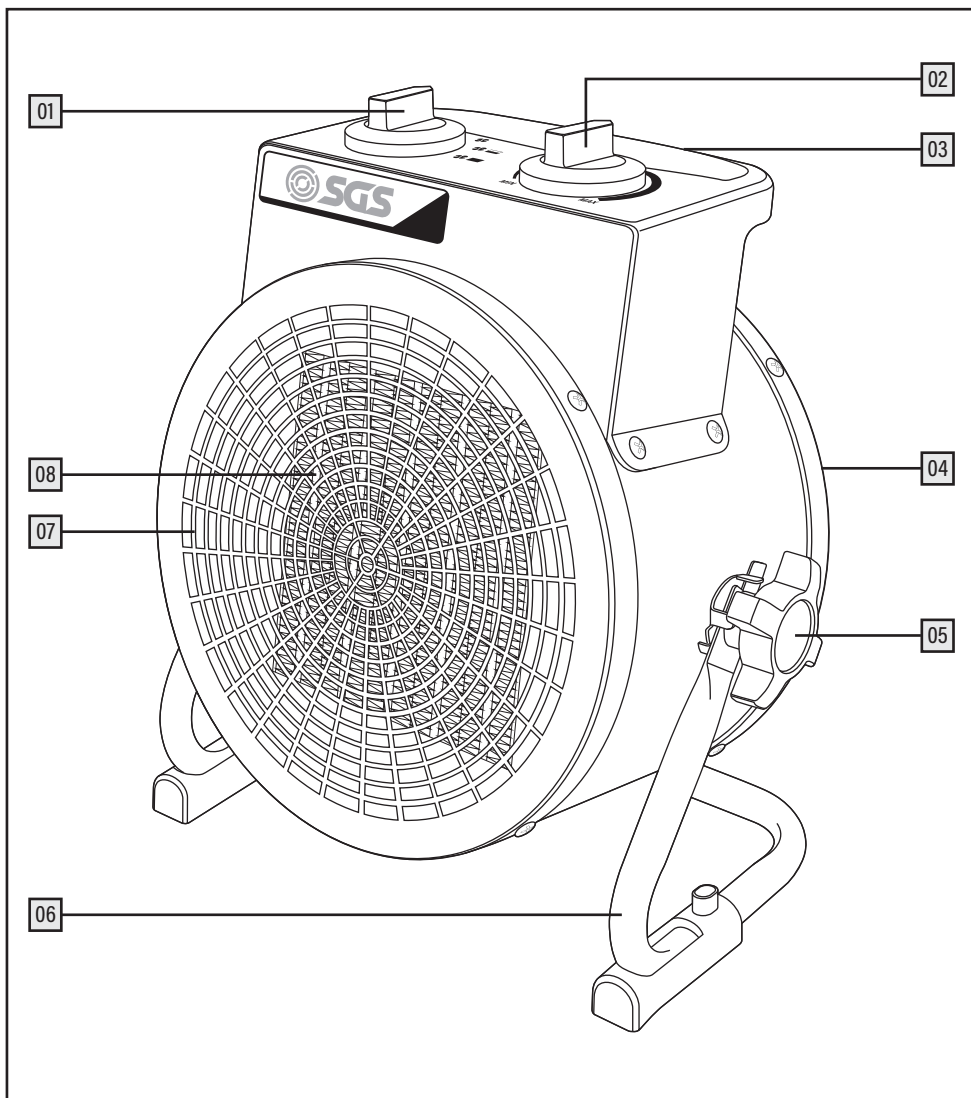

- 01. Operation control dial
- 02. Thermostat control dial
- 03. Carry handle
- 04. Inlet grille

- 05. Position adjustment knob
- 06. Stand
- 07. Outer grille
- 08. PTC heater element

## TECHNICAL SPECIFICATION

Rated Voltage	220-240V~50/60Hz	Fuse	13A
Rated Power	3000W	Maximum Heat Output:	10000 BTU
Position Settings	0W (OFF)	Thermal Cut-Out	150°C
	25W (Fan Only)	Heating Area	90-100m <sup>3</sup>
	1500W (Half Power)	Cable Length	1.2m
	3000W (Full Power)	Protection Type	IP20
Rated Current	13A	Weight	2.4kg

This unit is designed to raise the ambient temperature of an entire room, the temperature of the air coming out of the front of the heater will be warmer than the general temperature of the room, but there may not be a significant increase due to the large volume of air passing over the element. For the same reason, the element is hot during operation, but does not glow visibly. The room temperature depends on room size, insulation and the ambient temperature, which will increase as the room gets warmer.

## UNPACKING



**CAUTION:** This packaging contains sharp objects. Take care when unpacking.

Remove the machine, together with the accessories supplied, from the packaging. Check carefully to ensure that the machine is in good condition and account for all the accessories listed in this manual. Also make sure that all the accessories are complete.

If any parts are found to be missing, the machine and its accessories should be returned together in their

original packaging to the retailer. Do not throw the packaging away, keep it safe throughout the guarantee period, then recycle if possible, otherwise dispose of it by the proper means. Do not let children play with empty plastic bags due to the risk of suffocation. Take care when lifting the compressor from the packaging.

## OPERATING INSTRUCTIONS



**WARNING:** Before use, read and understand all the safety instructions listed in this manual. The heater may emit an odour during first use. This is normal and will pass shortly after switching on.



**WARNING:** DO NOT leave the heater unattended while it is connected to the power supply or switched on.

### POSITIONING THE HEATER

This heater is intended for use in small, enclosed spaces such as offices, home garages, etc.

Position the fan heater so that it stands upright unaided on a firm, level and fire-resistant surface and is located a safe distance away from flammable objects and wet environments.

MINIMUM CLEARANCE AROUND HEATER	
Top	1m
Sides	1m
Rear	1m
Front	2m

# OPERATING INSTRUCTIONS

Set the angle of the heater by loosening the position adjustment knobs (one either side of the heater) counter-clockwise, Fig.1, tilting the heater as required and then tightening the screws clockwise to secure it.

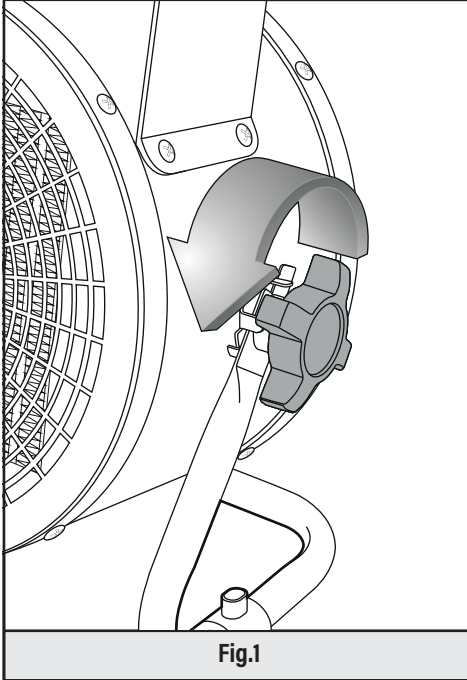

**CAUTION:** Always ensure that the position adjustment knobs are tightly secured before switching on the heater.



Ensure that the operation control dial is set to the off position (0) and the thermostat control dial is set to the lowest position (MIN), then connect the plug directly to a power outlet.

**WARNING:** DO NOT attempt to adjust the angle of the heater during or immediately after use. Always switch off the heater, disconnect the power supply and allow it to cool before loosening the position adjustment knobs.

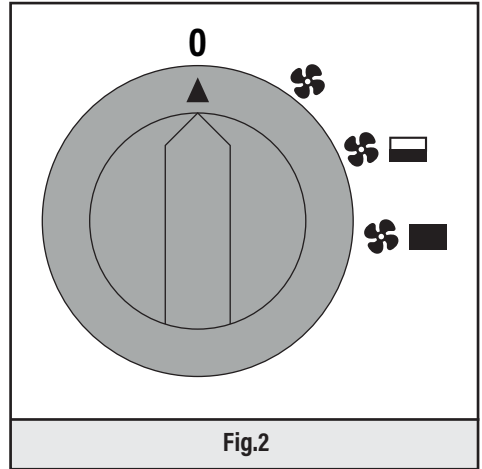
## OPERATION CONTROL DIAL (FIG.2)



The operation control dial has four operating positions:

POSITION	FUNCTION
0	Off (disconnect the power supply when not in use)
	Fan only (no heat)
	Half power (1500W)
	Full power (3000W)

## THERMOSTAT CONTROL DIAL (FIG.3)

The thermostat control dial can be used to set the desired room temperature. The heater will then maintain the chosen temperature automatically.

1. After connecting the heater to the power supply, turn the operation control dial (Fig.2) to the desired position.
2. Turn the thermostat control dial clockwise to the MAX position and allow the heater to heat the space in order to set the desired ambient temperature, Fig.3.

## OPERATING INSTRUCTIONS

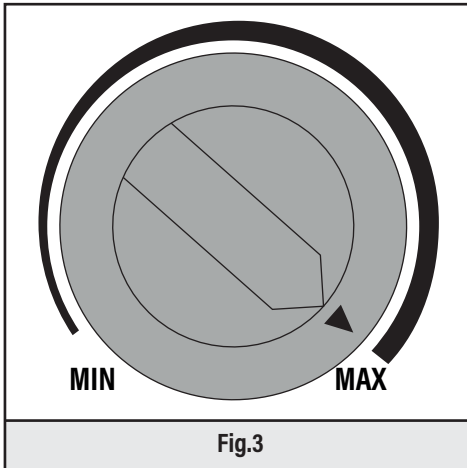

3. When the desired temperature is reached, turn the thermostat control dial anticlockwise until it "clicks," the thermostat will then automatically turn on and off to keep the room temperature constant.
4. **IMPORTANT:** If the fan only setting is selected on the operation control dial, the thermostat control dial must be set to its maximum position.

## MAINTENANCE & STORAGE



**WARNING:** Read all the Health and Safety information in this manual before attempting to maintain this product. All maintenance should be carried out only by authorised and suitably qualified personnel.



**WARNING:** Always unplug and disconnect the heater before carrying out any maintenance or cleaning.

Keep the heater clean and dry. Clean the heater body using a soft dry cloth only. **DO NOT** use abrasives or solvents.

Clean the heater grilles using a soft dry cloth or brush, ensuring that all dust and debris is collected and removed from the heater.

### SWITCHING OFF THE HEATER

Before switching off the heater, turn the operation control dial to the fan only setting  and turn the thermostat control dial clockwise to its maximum position. Allow the fan to blow for a few minutes to cool the heater element before turning both dials to their lowest position and disconnecting the power supply.

### THERMAL CUT-OUT FEATURE

The heater is equipped with a safety device that cuts the power to the heating element, which is activated when the heater overheats. When this occurs, the heater must be switched off, disconnected from the power supply and left to cool for at least ten minutes.



**IMPORTANT:** If overheating causes the heater to switch off automatically, the cause of overheating must be rectified before the product is used again.

Possible causes include covering of the inlet and outlet grilles or the fan being positioned too close to a wall or other object.

Once the heater has fully cooled, reconnect it to the power supply and switch it back on again.

If a problem with the heater is experienced, or the mains lead or plug is damaged, it must be replaced by the manufacturer, its service agent or suitably qualified personnel in order to avoid a hazard.

The heater should be inspected at least once a year by suitably qualified personnel.

Store the heater in its original bag and box, in a clean and dry location, out of reach of children.

**NOTICE:** Low pressure compressed air, or a vacuum cleaner could be used to blow/suck away any dust etc. that may build up inside the item or on the inlet or outlet grilles. Carry out this operation in a well ventilated area and use the appropriate eye and ear protection and a dust mask.

## TROUBLESHOOTING

PROBLEM	CAUSE	SOLUTION
The heater does not operate when switched on.	The power supply is not active.	Ensure that the power supply to which the heater is connected is switched on.
	The plug or cable connection is loose or damaged.	Remove the plug from the power supply and check it for damage or loose parts.
	Fuse is blown.	Check /replace the fuse
The heating element is glowing.	The input voltage is incorrect.	Disconnect the heater <b>IMMEDIATELY</b> and allow it to cool before reconnecting to a power supply matching the rating plate on the product.
	The input grille is blocked.	Disconnect the heater and check that the input grille is not obstructed by external objects. Allow the heater to cool, then clean the grille with a brush or soft dry cloth.
The heater does not emit heat.	The operation control dial is not set to one of the 2 heat settings.	Check and adjust the operation control dial accordingly.
	The ambient temperature is too high.	Increase the thermostat control setting or move the heater to a cooler environment.
	The thermal cut-out has been activated.	Switch off the heater, disconnect it from the power supply and allow it to cool for at least ten minutes. Check for and clear any blockages and obstructions. Reconnect the power and switch on the heater.
Heater does not turn on.	Fuse is blown.	Check /replace the fuse.
	Loose connection in wiring.	Have the heater checked by suitably qualified personnel.
The heater emits an unusual noise.	The fan is obstructed.	Switch off and disconnect the power supply and allow to cool. Check for any obstructions. Clean both grilles thoroughly. Contact SGS for support.
	The heater is not level.	Position on a flat and level surface.

## ***SERVICE***

---

Now that you have purchased your tool, should a need ever exist of repair or service, simply contact your nearest SGS Engineering Authorised Service Centre or other qualified service organisation. Be sure to provide all pertinent facts when you call or visit.

## ***ENVIRONMENTAL PROTECTION***

---

Information for (private householders) for the environmentally responsible disposal of Waste Electrical and Electronic Equipment (WEEE)



This symbol on products and or accompanying documents indicates that used and end of life electrical and electronic equipment should not be disposed of in household waste. For the proper disposal, treatment, recovery and recycling, please take these products to designated collection points, where they will be accepted on a free of charge basis. Alternatively, in some countries you may be able to return your products to your retailer upon the purchase of an equivalent new product. Disposing of this product correctly will help to save valuable resources and prevent any potential adverse effects on human health and the environment which could otherwise arise from inappropriate waste disposal and handling. Please contact your local authority for further details of your nearest designated collection point. Penalties may be applicable for incorrect disposal of this waste in accordance with national legislation.

### **FOR BUSINESS USERS IN THE EUROPEAN UNION.**

If you wish to discard electrical and electronic equipment, please contact your dealer or supplier for further information.

### **Information on Disposal in other Countries outside the European Union.**

This Symbol is only valid in the European Union. If you wish to dispose of this product, please contact your local authorities or dealer and ask for the correct method of disposal.

## ERP INFORMATION

ITEM	CAUSE	VALUE	UNIT	SOLUTION	UNIT
<b>Heat Output</b>					
Nominal heat output	P <sub>nom</sub>	3.0	kW	Manual heat charge control with integrated thermostat.	No
Minimum heat output (indicative)	P <sub>min</sub>	1.5	kW	Manual heat charge control with room and/or outdoor temperature feedback.	No
Maximum continuous heat output	P <sub>max,c</sub>	3.0	kW	Electronic heat charge control with room and/or outdoor temperature feedback.	No
Auxiliary electricity consumption				Fan assisted heat output.	No
At nominal heat output	e <sub>lmax</sub>	N/A	kW	Type of heat output/room temperature control (select one)	
At minimum heat output	e <sub>lmin</sub>	N/A	kW	Single stage heat output and no room temperature control.	No
In standby mode	e <sub>lSB</sub>	0	kW	Two or more manual stages, no room temperature control.	No
				With mechanical thermostat room temperature control.	Yes
				With electronic room temperature control.	No
				Electronic room temperature control plus day timer.	No
				Electronic room temperature control plus week timer.	No
				Other control options (multiple sections possible).	
				Room temperature control with presence detection.	No
				Room temperature control with open window detection.	No
				With distance control option	No
				With adaptive start option.	No
				With working time limitation.	No
				With black bulb sensor.	No
Contact details	SGS Engineering (UK) Ltd, Unit 1 West Side Park, Raynesway, Derby, DZ21 7AZ				

**NOTES**

---

A large rectangular area with a light gray background and horizontal lines, intended for writing notes. The area is bounded by a thin black border and contains 18 horizontal lines spaced evenly down the page.



# EC DECLARATION OF CONFORMITY

1. **Product model:** SPTCH3

2. **Name and address of the manufacturer or his authorised representative:**



SGS Engineering (UK) Ltd  
Unit 1 West Side Park, Raynesway, Derby, DE21 7AZ  
Telephone: +44 (0)1332 576 850

3. **This declaration of conformity is issued under the sole responsibility of the manufacturer.**

4. **Object of the declaration:**

**Equipment:** 3000W PTC Fan Heater  
**Brand name:** SGS  
**Model/type:** SPTCH3

5. **The object of the declaration described above is in conformity with the relevant statutory requirements:**

Electrical Equipment (Safety) Regulations 2016  
Electromagnetic Compatibility Regulations 2016  
The Ecodesign for Energy-Related Products and Energy Information (Amendment) (EU Exit) Regulations 2019  
The Restriction of the Use of Certain Hazardous Substances in Electrical and Electronic Equipment Regulations 2012

6. **References to the relevant designated standards used or references to the other technical specifications in relation to which conformity is declared:**

BS EN 60335-2-30	BS EN 55014-2
BS EN 60335-1	BS EN IEC 61000-3-2
BS EN 62233	BS EN 61000-3-3
BS EN 55014-1	

7. **The person authorized to compile the technical file:**

**Name:** Neil Sansom  
**Address:** SGS Engineering (UK) Ltd, Unit 1 West Side Park, Raynesway, Derby, DE21 7AZ

**Signed for and on behalf of:**

Authorised Representative

A handwritten signature in black ink, appearing to read 'Neil Sansom'.

Neil Sansom, CEO  
**Date:** 04/06/2025

UK  
CA 25